



V43/V243 Series Pressure-Actuated Water-Regulating Valves Catalog Page

Description

The V43/V243 Pressure Actuated Water Regulating Valves are designed to regulate water flow through the condenser of large refrigerated cooling systems. These pilot-operated valves open on an increase in refrigerant head pressure and provide modulating operation.

The V43/V243 water regulating valves are available for commercial and maritime applications.

V43 valves are available for non-corrosive low- and medium-pressure refrigerants such as R-134A, R-404A, R-502, and R-507. Specially designed V43 valves are also available for ammonia service (R-717).

V243 valves are available for non-corrosive high-pressure refrigerants such as R410A.

Commercial V43/V243 valves are constructed with a cast iron body, brass internal parts, and bronze seat material.

To resist the corrosive action of sea water, the V43/V243 maritime and navy models are constructed with a red brass body, bronze and monel interior parts, and monel seat material.

Refer to the *V43/V243 Pressure Actuated Water Regulating Valves Product/Technical Bulletin (LIT-125683)* for important product information.

Features

- built-in pilot valve allows more precise throttling
- easy adjustment allows service and adjustment without breaking line connections
- drain plug allows water to be drained during shutdown to reduce the possibility of freeze-up
- mesh monel screen protects pilot valve from items such as dirt and scale and is easily removed for cleaning and servicing without breaking any line connections

Repairs and Replacement

If a V43/V243 Pressure-Actuated Water-Regulating Valve fails to operate within its specifications, replacement sensing elements, internal parts, and diaphragms are available for valve repair.

To obtain replacement parts, kits, instructions, and details, contact your nearest Johnson Controls® distributor.

For replacement parts, see Repair Parts and Parts Kits.



V43 Pressure Actuated Valve

Selection Charts

When ordering V43 valves, specify the complete product code number including an optional companion flange and gasket kit. A companion flange and gasket kit is required to mount the water lines to commercial type V43/V243 water-regulating valves.



This product is made of copper alloy, which contains lead. The product is therefore not to be used on drinking water.

Valve Construction and Pressure Type

Designator	Construction and Pressure Type
A	Commercial Service with Iron Body, Open on Pressure Increase, V43
B	Maritime Service with Brass Body, Open on Pressure Increase, V43
C	Navy Service with Brass Body, Open on Pressure Increase, V43
G	Commercial Service with Iron Body, Open on Pressure Increase, V243
H	Maritime Service with Brass Body, Open on Pressure Increase, V243

Flange Size

Designator	Flange Size
S	2 in.
T	2-1/2 in.
V	3 in.
W	4 in.

V43 Series Pressure Actuated Water Valves (except NAVSEA valves)

Product Code Number	Pipe Size (in.)	Inlet and Outlet	Opening Point Adjustment Range psig (kPa)	Shipping Wt. lb (kg) (Part 1 of 2)
Commercial Type – Non-Corrosive Refrigerants (R)				
V43AS-1C	2	Four Hole ASME Flanged	70 to 150 (483 to 1,034)	59 (26.76)
V43AS-2C	2-1/2		160 to 260 (1,103 to 1,793)	
V43AT-1C			70 to 150 (483 to 1,034)	65 (29.48)
V43AT-2C	140 to 260 (1,103 to 1,793)			
V43AV-1C	3	Eight Hole ASME Flanged	70 to 150 (483 to 1,034)	90 (40.82)
V43AV-2C	4		160 to 260 (1,103 to 1,793)	90 (40.82)
V43AW-2C				142 (64.41)
Commercial Type - Ammonia (R)				
V43AV-5C	3		160 to 260 (1,103 to 1,793)	90 (40.82)

The performance specifications are nominal and conform to acceptable industry standards. For applications at conditions beyond these specifications, consult the local Johnson Controls office. Johnson Controls shall not be liable for damages resulting from misapplication or misuse of its products. © 2018 Johnson Controls. www.penncontrols.com



V43/V243 Series Pressure-Actuated Water-Regulating Valves Catalog Page (Continued)

Selection Charts (Continued)

Product Code Number	Pipe Size (in.)	Inlet and Outlet	Opening Point Adjustment Range psig (kPa)	Shipping Wt. lb (kg) (Part 2 of 2)
Maritime Type – Non-Corrosive Refrigerants (R)				
V43BS-6C	2	Four Hole ASME Flanged	70 to 150 (483 to 1,034)	59 (26.76)
V43BS-7C			160 to 260 (1,103 to 1,793)	
V43BT-6C	2-1/2		70 to 150 (483 to 1,034)	65 (29.48)
V43BT-7C			140 to 260 (1,103 to 1,793)	
V43BV-10C	3	70 to 150 (483 to 1,034)	90 (40.82)	
V43BV-7C		140 to 260 (1,103 to 1,793)		

V43 Series Pressure Actuated Water valves, Navy NAVSEA Certified

Product Code Number	Pipe Size (in.)	Inlet and Outlet	Pressure Connector	Opening Point Adjustment Range – psig (kPa)	Shipping Wt. lb (kg)
Navy NAVSEA Certified – Non-Corrosive Refrigerants (R)					
V43BS-3C	2	Four Hole ASME Flange	1/4 in. External Flared Connector	70 to 150 (483 to 1,034)	59 (26.76)
V43CS-1C		Six Hole Navy Flange			
V43CS-2C		Internal Sweat Connector			
V43BT-3C	2-1/2	Four Hole ASME Flange	1/4 in. External Flared Connector		65 (29.48)
V43CT-2C		Six Hole Navy Flange			
V43BV-4C	3	Four Hole ASME Flange	Internal Sweat Connector	90 (40.82)	
V43CV-1C		Eight Hole Navy Flange	1/4 in. External Flared Connector		
V43CV-2C			Internal Sweat Connector		
V43BW-7C	4	Eight Hole ASME Flange	1/4 in. External Flared Connector	142 (64.41)	
V43BW-2C					140 to 260 (1,103 to 1,793)

V243 Series Pressurized Actuated Water Valves

Product Code Number	Pipe Size (in.)	Inlet and Outlet	Opening Point Adjustment Range – psig (kPa)	Shipping Weight, lb (kg)
Commercial Type – High Pressure Refrigerants				
V243GS-1C	2	Four Hole ASME Flange	200 to 400 (1,379 to 2,758)	59 (26.76)
V243GT-1C	2-1/2			65 (29.48)
V243GV-1C	3	90 (40.82)		
V243GW-1C	4	Eight Hole ASME Flange		142 (64.41)
Maritime Type – High Pressure Refrigerants				
V243HS-1C	2	Four Hole ASME Flange	200 to 400 (1,379 to 2,758)	59 (26.76)
V243HT-1C	2-1/2			65 (29.48)
V243HV-1C	3	90 (40.82)		
V243HW-1C	4	Eight Hole ASME Flange		142 (64.41)

Accessories

Kit Code Number	Water Valve Size (in.)	Shipping Weight, lb (kg)
KIT14A-613 ^{1, 2}	2	11.8 (5.4)
KIT14A-614 ^{1, 2}	2-1/2	16.5 (7.5)
FLG15A-600 ^{1, 3}	3	20 (9.1)
FLG15A-601 ^{1, 3}	4	34 (15.4)

- Commercial valves only.
- These are the parts included in the flange and gasket kit for the 2-inch and 2-1/2 inch valves.
- These are the parts included in the flange and gasket kit for the 3-inch and 4-inch valves.

A companion flange and gasket kit is required to mount the water lines to commercial type V43/V243 water-regulating valves.

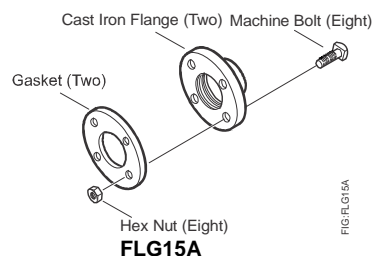
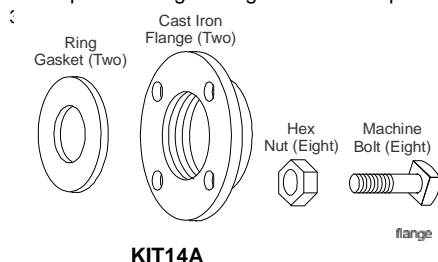



V43/V243 Series Pressure-Actuated Water-Regulating Valves Catalog Page (Continued)

Repair Parts

Repair Parts (Part 1 of 2)

Model	Diaphragm Kit	Seat Disc and Diaphragm Kit	Seat Repair Kit	Screen Repair Kit	Push Rod Kit ¹	Sensing Element Kit	Disc Body Kit
V43AS-1C	DPM18A-600R	DSC16A-600R	STT19A-602R	SCN10A-600R	ROD18A-600R	SEP88A-600R	DBK11A-600R
V43AS-2C	DPM18A-600R	DSC16A-600R	STT19A-602R	SCN10A-600R	ROD18A-600R	SEP88A-601R	DBK11A-600R
V43AS-5C	DPM18A-600R	DSC16A-600R	STT19A-602R	SCN10A-600R	ROD18A-600R	SEP87A-600R	DBK11A-600R
V43AT-1C	DPM18A-601R	DSC16A-601R	STT19A-603R	SCN10A-600R	ROD18A-601R	SEP88A-600R	DBK11A-601R
V43AT-2C	DPM18A-601R	DSC16A-601R	STT19A-603R	SCN10A-600R	ROD18A-601R	SEP88A-601R	DBK11A-601R
V43AT-5C	DPM18A-601R	DSC16A-601R	STT19A-603R	SCN10A-600R	ROD18A-601R	SEP87A-600R	DBK11A-601R
V43AV-1C	DPM18A-602R	DSC16A-602R	STT19A-606R	SCN10A-600R	ROD18A-601R	SEP88A-600R	DBK11A-602R
V43AV-2C	DPM18A-602R	DSC16A-602R	STT19A-606R	SCN10A-600R	ROD18A-601R	SEP88A-601R	DBK11A-602R
V43AV-5C	DPM18A-602R	DSC16A-602R	STT19A-606R	SCN10A-600R	ROD18A-601R	SEP87A-600R	DBK11A-602R
V43AW-1C	DPM18A-603R	DSC16A-603R	STT19A-608R	SCN10A-600R	ROD18A-602R	SEP88A-600R	DBK11A-603R
V43AW-2C	DPM18A-603R	DSC16A-603R	STT19A-608R	SCN10A-600R	ROD18A-602R	SEP88A-601R	DBK11A-603R
V43AW-5C	DPM18A-603R	DSC16A-603R	STT19A-608R	SCN10A-600R	ROD18A-602R	SEP87A-600R	DBK11A-603R
V43BS-1C ¹	DPM18A-600R	DSC16A-600R	STT19A-602R	SCN10A-601R	ROD18A-602R	SEP88A-600R	DBK11A-600R
V43BS-2C ¹	DPM18A-600R	DSC16A-600R	STT19A-602R	SCN10A-601R	ROD18A-602R	SEP88A-601R	DBK11A-600R
V43BS-3C	DPM18A-600R	DSC16A-600R	STT19A-600R	SCN10A-601R	ROD18A-602R	SEP88A-600R	DBK10A-600R
V43BS-6C	DPM18A-600R	DSC16A-600R	STT19A-600R	SCN10A-601R	ROD18A-602R	SEP88A-600R	DBK10A-600R
V43BS-7C	DPM18A-600R	DSC16A-600R	STT19A-600R	SCN10A-601R	ROD18A-602R	SEP88A-601R	DBK10A-600R
V43BT-1C ¹	DPM18A-601R	DSC16A-601R	STT19A-603R	SCN10A-601R	ROD18A-603R	SEP88A-600R	DBK11A-601R
V43BT-2C ¹	DPM18A-601R	DSC16A-601R	STT19A-603R	SCN10A-601R	ROD18A-603R	SEP88A-601R	DBK11A-601R
V43BT-3C	DPM18A-601R	DSC16A-601R	STT19A-605R	SCN10A-601R	ROD18A-603R	SEP88A-600R	DBK10A-602R
V43BT-6C	DPM18A-601R	DSC16A-601R	STT19A-605R	SCN10A-601R	ROD18A-603R	SEP88A-600R	DBK10A-602R
V43BT-7C	DPM18A-601R	DSC16A-601R	STT19A-605R	SCN10A-601R	ROD18A-603R	SEP88A-601R	DBK10A-602R
V43BV-1C ¹	DPM18A-602R	DSC16A-602R	STT19A-606R	SCN10A-601R	ROD18A-603R	SEP88A-600R	DBK11A-602R
V43BV-2C ¹	DPM18A-602R	DSC16A-602R	STT19A-606R	SCN10A-601R	ROD18A-603R	SEP88A-601R	DBK11A-602R
V43BV-4C	DPM18A-602R	DSC16A-602R	STT19A-607R	SCN10A-601R	ROD18A-603R	SEP88A-600R	DBK10A-601R
V43BV-5C ¹	DPM18A-602R	DSC16A-602R	STT19A-606R	SCN10A-601R	ROD18A-603R	SEP88A-600R	DBK11A-602R
V43BV-6C ¹	DPM18A-602R	DSC16A-602R	STT19A-606R	SCN10A-601R	ROD18A-603R	SEP88A-601R	DBK11A-602R
V43BV-7C	DPM18A-602R	DSC16A-602R	STT19A-607R	SCN10A-601R	ROD18A-603R	SEP88A-601R	DBK10A-601R
V43BV-8C	DPM18A-602R	DSC16A-602R	STT19A-607R	SCN10A-601R	ROD18A-603R	SEP88A-600R	DBK10A-601R
V43BV-9C	DPM18A-602R	DSC16A-602R	STT19A-607R	SCN10A-601R	ROD18A-603R	SEP88A-601R	DBK10A-601R
V43BV-10C	DPM18A-602R	DSC16A-602R	STT19A-607R	SCN10A-601R	ROD18A-603R	SEP88A-600R	DBK10A-601R
V43BW-1C	DPM18A-603R	DSC16A-603R	STT19A-609R	SCN10A-601R	ROD18A-602R	SEP88A-600R	DBK10A-603R
V43BW-2C	DPM18A-603R	DSC16A-603R	STT19A-609R	SCN10A-601R	ROD18A-602R	SEP88A-601R	DBK10A-603R
V43BW-5C	DPM18A-603R	DSC16A-603R	STT19A-609R	SCN10A-601R	ROD18A-602R	SEP88A-600R	DBK10A-603R
V43BW-6C	DPM18A-603R	DSC16A-603R	STT19A-609R	SCN10A-601R	ROD18A-602R	SEP88A-601R	DBK10A-603R
V43BW-7C	DPM18A-603R	DSC16A-603R	STT19A-609R	SCN10A-601R	ROD18A-602R	SEP88A-600R	DBK10A-603R
V43CS-1C	DPM18A-600R	DSC16A-600R	STT19A-600R	SCN10A-601R	ROD18A-602R	SEP88A-600R	DBK10A-600R
V43CS-2C	DPM18A-600R	DSC16A-600R	STT19A-600R	SCN10A-601R	ROD18A-602R	SEP88A-600R	DBK10A-600R
V43CS-3C	DPM18A-600R	DSC16A-600R	STT19A-600R	SCN10A-601R	ROD18A-604R	SEP88A-600R	DBK10A-600R
V43CT-1C	DPM18A-601R	DSC16A-601R	STT19A-605R	SCN10A-601R	ROD18A-603R	SEP88A-600R	DBK10A-602R
V43CT-2C	DPM18A-601R	DSC16A-601R	STT19A-605R	SCN10A-601R	ROD18A-603R	SEP86A-600R	DBK10A-602R
V43CV-1C	DPM18A-602R	DSC16A-602R	STT19A-607R	SCN10A-601R	ROD18A-603R	SEP86A-600R	DBK10A-601R
V43CV-2C	DPM18A-602R	DSC16A-602R	STT19A-607R	SCN10A-601R	ROD18A-603R	SEP88A-600R	DBK10A-601R
V243GS-1C	DPM18A-600R	DSC16A-600R	STT19A-602R	SCN10A-600R	ROD18A-600R	SEP90A-600R	DBK11A-600R
V243GT-1C	DPM18A-601R	DSC16A-601R	STT19A-603R	SCN10A-600R	ROD18A-601R	SEP90A-600R	DBK11A-601R
V243GV-1C	DPM18A-602R	DSC16A-602R	STT19A-606R	SCN10A-600R	ROD18A-601R	SEP90A-600R	DBK11A-602R
V243GW-1C	DPM18A-603R	DSC16A-603R	STT19A-608R	SCN10A-600R	ROD18A-600R	SEP90A-600R	DBK11A-603R
V243HS-1C	DPM18A-600R	DSC16A-600R	STT19A-600R	SCN10A-601R	ROD18A-602R	SEP90A-600R	DBK10A-600R
V243HT-1C	DPM18A-601R	DSC16A-601R	STT19A-605R	SCN10A-601R	ROD18A-603R	SEP90A-600R	DBK10A-601R

The performance specifications are nominal and conform to acceptable industry standards. For applications at conditions beyond these specifications, consult the local Johnson Controls office. Johnson Controls shall not be liable for damages resulting from misapplication or misuse of its products. © 2018 Johnson Controls. www.penncontrols.com



V43/V243 Series Pressure-Actuated Water-Regulating Valves Catalog Page (Continued)

Repair Parts (Part 2 of 2)

Model	Diaphragm Kit	Seat Disc and Diaphragm Kit	Seat Repair Kit	Screen Repair Kit	Push Rod Kit ¹	Sensing Element Kit	Disc Body Kit
V243HV-1C	DPM18A-602R	DSC16A-602R	STT19A-607R	SCN10A-601R	ROD18A-603R	SEP90A-600R	DBK10A-602R
V243HW-1C	DPM18A-603R	DSC16A-603R	STT19A-609R	SCN10A-601R	ROD18A-602R	SEP90A-600R	DPK10A-603R

1. Replacement push rod kit requires a seat repair kit and/or a diaphragm kit when replaced.

Parts Kits

The following valves, manufactured after date code 8702, contain monel interior trim. Order replacement kits as listed in Repair Parts or V43xx and V243xx Series Repair Parts Kits Technical Bulletin (LIT-121690).

Parts Kits

Valve Model	Order Parts Kits for:
V43BS-1C	V43BS-6C
V43BS-2C	V43BS-7C
V43BT-1C	V43BT-6C
V43BT-2C	V43BT-7C
V43BV-1C	V43BV-10C
V43BV-2C	V43BV-7C
V43BV-5C	V43BV-10C
V43BV-6C	V43BV-9C

Dimensions

Symbol	2 Inch	2-1/2 Inch	3 Inch	4 Inch
A ¹	9-1/2 in. (241 mm)	10-3/4 in. (273 mm)	11-3/4 in. (298 mm)	14 in. (356 mm)
B	7-1/2 in. (191 mm)	8 in. (203 mm)	9 in. (229 mm)	10-3/4 in. (273 mm)
C	4-3/4 in. (121 mm)	5-1/2 in. (140 mm)	6 in. (152 mm)	7-1/2 in. (191 mm)
D	6 in. (152 mm)	7 in. (178 mm)	7-1/2 in. (191 mm)	9 in. (229 mm)
E	2-1/8 in. (54 mm)	2-5/8 in. (67 mm)	3-1/8 in. (80 mm)	4-1/8 in. (105 mm)
F ²	15-1/4 in. (387 mm)	15-9/16 in. (395 mm)	16-9/16 in. (421 mm)	18-7/32 in. (462 mm)
F ³	15-29/32 in. (404 mm)	16-7/32 in. (412 mm)	17-7/32 in. (437 mm)	18-7/8 in. (479 mm)
G	3/4 in. (19 mm) Diameter (Four)	3/4 in. (19 mm) Diameter (Four)	3/4 in. (19 mm) Diameter (Four)	3/4 in. (19 mm) Diameter (Eight)
H	3-5/8 in. (92 mm)	3-15/16 in. (100 mm)	4-1/4 in. (108 mm)	5-1/16 in. (128 mm)

1. Flange face to flange face.
2. These are the measurements for the V43 valves.
3. These are the measurements for the V243 valves.

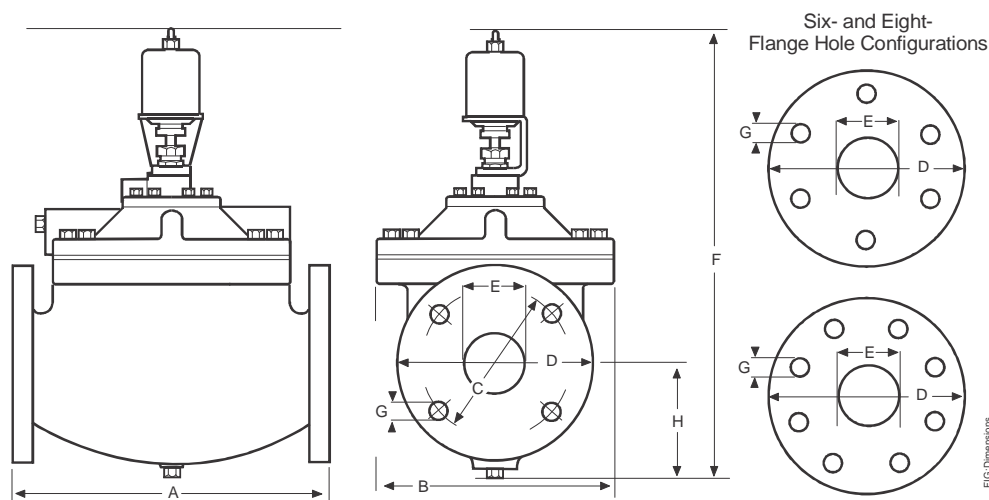

V43/V243 Pressure Actuated Water Regulating Valves Dimensions

The performance specifications are nominal and conform to acceptable industry standards. For applications at conditions beyond these specifications, consult the local Johnson Controls office. Johnson Controls shall not be liable for damages resulting from misapplication or misuse of its products. © 2018 Johnson Controls. www.penncontrols.com



V43/V243 Series Pressure-Actuated Water-Regulating Valves Catalog Page (Continued)

V43 Capacity Flow Charts

CAPACITY CHART FOR 2 in. VALVE

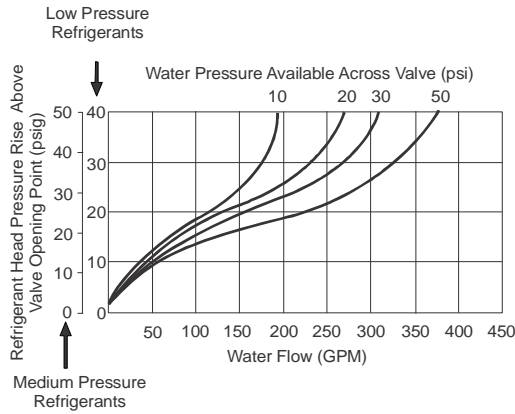

CAPACITY CHART FOR 3 in. VALVE

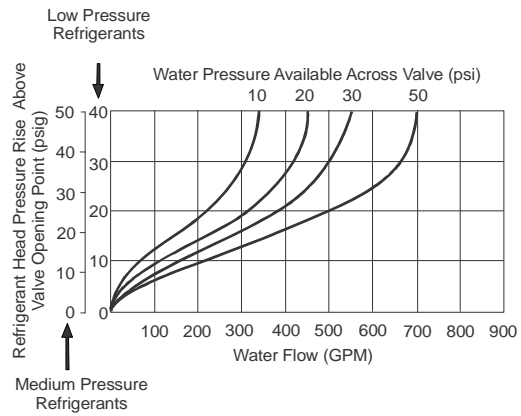

CAPACITY CHART FOR 2-1/2 in. VALVE

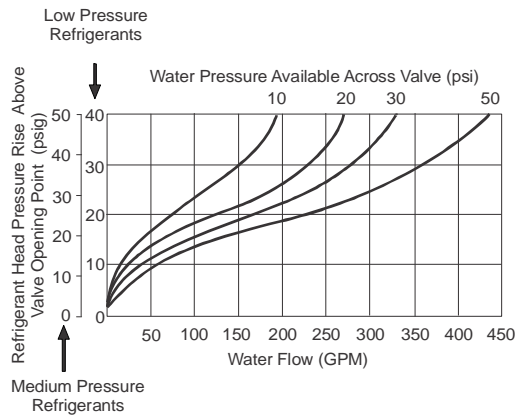

CAPACITY CHART FOR 4 in. VALVE

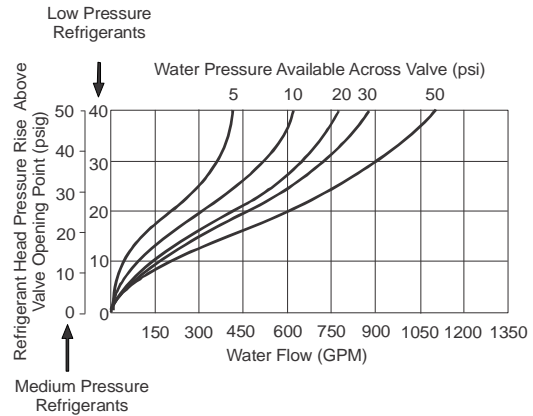



V43/V243 Series Pressure-Actuated Water-Regulating Valves Catalog Page (Continued)

V243 Capacity Flow Charts

CAPACITY CHART FOR 2 in. VALVE

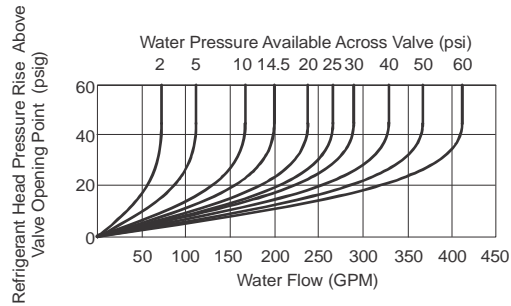

CAPACITY CHART FOR 3 in. VALVE

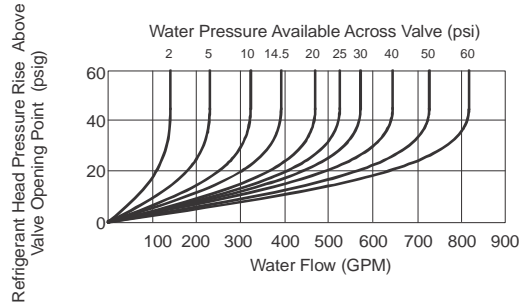

CAPACITY CHART FOR 2-1/2 in. VALVE

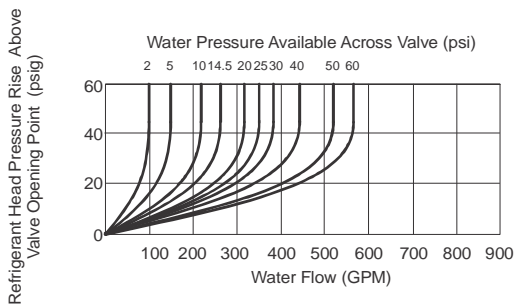

CAPACITY CHART FOR 4 in. VALVE

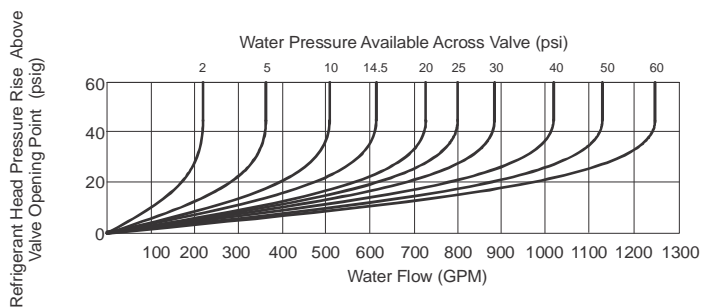

Technical Specifications

V43/V243 Pressure-Actuated Water-Regulating Valves			
Maximum Water Supply Pressure		150 psig (1,034 kPa)	
V43 Maximum Head Pressure		300 psig (2,068 kPa)	
V243 Maximum Head Pressure		630 psig (4,344 kPa)	
Head Pressure Range (Opening Points)	V43	Low Pressure Refrigerants	R-134A – 70 to 150 psig (482 to 1,034 kPa)
		Medium Pressure Refrigerants	R-22, R-502, R404A – 160 to 260 psig (1,103 to 1,793 kPa)
		Ammonia	160 to 260 psig (1,103 to 1,793 kPa)
	V243	High Pressure	200 to 400 psig (1,379 to 2,758 kPa)
Factory Settings ¹	V43	Low Pressure Refrigerants	90 psig (621 kPa)
		Medium Pressure Refrigerants	180 psig (1,241 kPa)
		Ammonia	180 psig (1,241 kPa)
	V243	High Pressure	200 psig (1,379 kPa)
Maximum Water Supply Temperature		160°F (71°C)	
Valve Body Material	Commercial	Cast iron	
	Maritime	Red brass	
Internal Parts Material	Commercial	Brass	
	Maritime	Bronze, Monel	
Seat Material	Pilot	Monel	
	Main Valve	Commercial – Bronze, Maritime – Monel	
Seat Disc Material		Buna N™	
Packing – Bellows Assembly		Brass stem, stainless steel spring, synthetic rubber boot	
Pressure Connection Refrigerant Side	Non-Corrosive	1/4 in. SAE External Flare	
	Ammonia	1/4 in. FNPT	

1. Factory opening setpoint for the valve is adjustable.